

SULLY - 315LF 4C

315 - 4 COLOURS LED 200W



- **Type:** Single lens luminaire
- **Source:** 4 colours LED 200W
- **Optics:** 200 mm Fresnel lens

Single lens

The multifunctional coloured LED spot

Providing a multi-faceted solution in a compact package, Sully 4C 315LF Fresnel combines a high-quality 200W 4-colour LED source with a single 200 mm Fresnel lens, which can be easily changed for a Pebble Convex lens. It offers broad coverage with even beam, for smooth matches between fixtures when installed side by side. Integrating an innovative software platform named RJ Color, its advanced setting modes ensure perfect whites and high quality saturated and pastel colours. In addition to low power consumption and low heat generation, Sully 4C 315LF delivers consistent colour rendition when dimming.

Features

- **Light intensity:** 8 or 16 bit dimming and strobe function
- **Colour control:** CIE XY, Hue saturation, RGB (with choice of the colour space - Native / sRGB / REC.709 / REC.2020 / ProPhoto) or RAW modes
- **Calibrated white sources:** 3 white presets reproducing tungsten 3000 K or 3200 K lamps, or discharge 6500 K lamps
- **Colour Temperature adjustment (CCT):** white from 1700 to 10000 Kelvin with Delta UV control (+/- Green – Magenta)
- **Colour mixing optimization:** choice of High Quality or High Brightness mode
- **Colour filter simulation:** 300 colour filters included with transmission / saturation adjustment - Fade time and type adjustment between 2 colour filters for adjustable transition
- **DimShift function:** when dimming the light, the colours follow the Planck curve (tungsten redshift emulation) - Available on all sources (white presets, any CCT value) and all colour filters
- **1 parameter DMX mode:** filter or colour selection through local display and dimming control by DMX (8 or 16 bits)
- **Adjustable response time:** choice of fast or slow dimming for tungsten-like simulation - adjustment by DMX - 3 modes available: tungsten, linear and linear with flash detection
- **Theatre front cassette:** no light spill to distract audiences or performers
- **Accessories holder:** double runners to hold accessories and colour filters
- **Barn door:** unique rotating barn door with 4 individually rotating blades – makes even the most difficult angle possible
- **PWM adjustment:** choice of different PWM dimming frequencies
- **Local setup:** dMX address and mode, dimming curve and response time through 4-button display with automatic light switch-off
- **Dimming parameters:** choice of square, linear or tungsten dimming curves
- **Focus reference:** index for easy focus reference
- **Focus adjustment:** smooth focus adjustment from rear
- **Tilt reference on hanging yoke:** index for rapid re-positioning

Optical

- **Long life:** outstanding operational lifetime expectation, no need to replace lamps, low maintenance
- **4-colour mixing LED system:** Red, Green, Blue, and Lime
- **Thermal management of each colour:** thanks to the thermal management algorithms, the colours you have set will stay the same during the performance
- **Factory calibrated source:** to ensure consistency between fixtures
- **Beam shaping :** efficient barndoors in any focus position
- **Electronic dimmer:** dimming without clipping or cut-out at low intensity levels; high quality smoothing

Construction

- **Made in France :** fully manufactured in Robert Juliat premises retaining complete control over all aspects of quality
- **PSU:** built-in electronic flicker-free power supply for easy, plug-and-play installation
- **Power connectors:** neutriK® powerCON TRUE1 TOP IN and OUT connectors for daisy chaining
- **Silent-running cooling fans:** ideal for TV studios and opera houses
- **Electronic thermal management system:** ensures maximum performance of the system without any risk of overheating
- **Bodywork:** strong sheet metal construction for durability
- **Captive knobs and handles:** additional security when working at height or in transit
- **Easy access to all parts:** easy cleaning and maintenance

Picture:315LF 4C

DSEN408_315LF_4C_Preliminary - 20/09/2022 - Preliminary data
Robert Juliat reserves the right to change or alter any of the items detailed on this page, to increase or improve manufacturing techniques without prior notice.
Robert Juliat S.A.S., 32 rue de Beaumont, 60530 Fresnoy-en-Thelle - France
Telephone : +33 (0)3 44 26 51 89 - fax : +33 (0)3 44 26 90 79 - info@robertjuliat.fr
www.robertjuliat.com



ROBERT JULIAT

Source

- **Lamp type:** LED - 4 colours
- **Lumen output:** 8100 lm
- **Life:** hours (LM70)

Colours	Power *	Lumen output*	Colour temperature*	CRI* (min)
Red		1 600 lm		
Green		2 900 lm		
Blue		500 lm		
Lime		3 100 lm		

(*) manufacturer's data

Optics

Characteristics

- **Type:** Single lens
- **Beam range:** ° to °
- **Lens:** 200 mm Fresnel lens

Gel filter

- **Shape:** Square
- **Standard size:** 215x215 mm (8.5x8.5 in)

Installation and photometrics

Remote control

- **Data protocol:** USITT DMX512-A
RDM

- **Data IN connector:** 5 pins XLR male
- **Data OUT connector:** 5 pins XLR femelle



• DMX chart:

Mode 1 (1 channels)

Dimmer

Mode 2 (6 channels)

Dimmer
Dimmer fine
Strobe duration
Strobe speed
Response time
Control mode

Mode 3 (20 channels)

Dimmer @16b
Strobe: duration + speed
Response time
Control mode
Source type
Filter + adjustments
CCT + delta UV
CIE XY Colour control @16b

Mode 4 (20 channels)

Dimmer @16b
Strobe: duration + speed
Response time
Control mode
Source type
Filter + adjustments
CCT + delta UV
Hue Saturation @16b

Mode 5 (22 channels)

Dimmer @16b
Strobe: duration + speed
Response time
Control mode
Source type
Filter + adjustments
CCT + delta UV
RGB colour control @16b

Mode 6 (24 channels)

Dimmer @16b
Strobe: duration + speed
Response time
Control mode
Source type
Filter + adjustments
CCT + delta UV
RGLB colour control @16b

Dimensions and weight

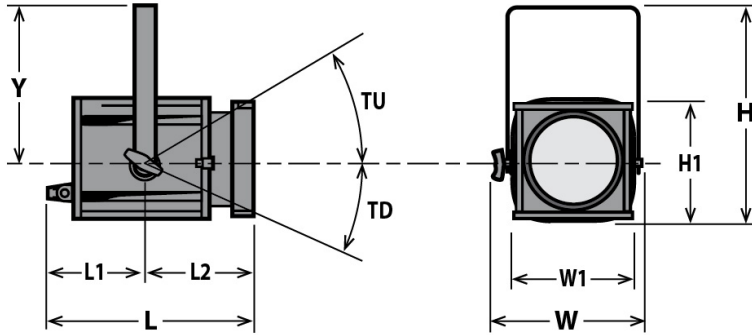

Weight: 11 kg (24.2 lbs)

Height	Length	Width	Yoke	Tilt
H= 440 mm (17.3 in) H1= 250 mm (9.8 in)	L= 465 mm (18.3 in) L1= 260 mm (10.2 in) L2= 205 mm (8.1 in)	W= 350 mm (13.8 in) W1= 250 mm (9.8 in)	Y= 315 mm (12.4 in)	TU= TBD° TD= 90°

Shipping

- **Weight :**
- **Volume :**

Installation

- **Minimum distance to illuminated surface:** (0.0 ft)
- **Operating position:**



Warranty

- **Fixture: 3 years**
See General Sales Condition on website

Approvals



Construction

- **Housing:** Steel sheet - Aluminium
- **Colour:** Black
- **Cooling:** Low noise variable fan
- **Maximum ambient temperature (Ta):** 40°C (104°F)
- **Maximum case temperature (Tc):** °C (°F)
- **Total heat dissipation:** 696 BTU/h
- **Ingress Protection (IP) rating:** IP20

Electrical compatibility

- 220/230 V - 50 Hz
- 245 V - 50 Hz
- 110/120 V - 60 Hz
- 208 V - 60 Hz
- 220/230 V - 60 Hz
- 100 V - 50 Hz
- 100 V - 60 Hz
- Selector: automatic detection

Power input



- **Type:** removable power cord with Neutrik powerCON TRUE1 TOP connector (included)
- **Cable:** H07RNF 3G1.5
- **Length:** 3 m (9.8 ft)
- **Power connector:** CEE 7/7 (2P+E NF/Schuko)

Power consumption

Voltage	Frequency	Current	Power	Power factor
230 V	50 Hz	1 A	204 W	0.9
110 V	60 Hz	1.9 A	207 W	0.98
100 V	60 Hz	2.1 A	207 W	0.99

Power Supply Unit

- **PSU:** Internal - Electronic PSU - Flicker free with PFC
- **Control:** / DMX
- **Protection:** Mains: 2x 6.3A 5x20 T fuses /







Model

315LF 4C	4 colours LED 200W Single lens luminaire - 200mm Fresnel - 315LF 4C Sully
-----------------	---

Options

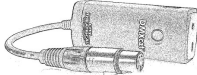
PCP1716A	16A blue 2P+E 6h IEC60309 power connector	
-----------------	---	---

Accessories

PF1000M2	215x215mm metal filter holder 1 included	
CF1000	4 rotating leaves on a rotating barndoor - 215x215mm (without safety cable) - Poids: 1.03 Kg	
DMXcat	Bluetooth DMX/RDM Multifunction test tool - City Theatrical DMXcat®	
876	Hook clamp 40x10mm with 28mm M10 screw for Ø35 to 50mm pipes - SWL: 50Kg - Poids: 1.25 Kg	
880	Hook clamp 40x10mm with 28mm M10 screw for Ø50 to 63mm pipes - SWL: 50Kg - Poids: 1.36 Kg	
CS2	Safety cable Ø3 mm L= 600mm - SWL: 75 Kg	
CS5	Safety cable Ø1,5 mm L=300mm for front accessory with karabiner and quick link - SWL: 25 Kg	